

Gancho Doble Clásica

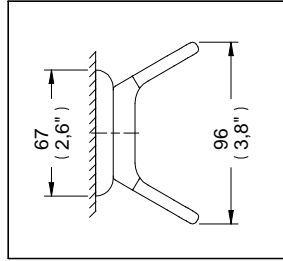

Medidas Referenciales

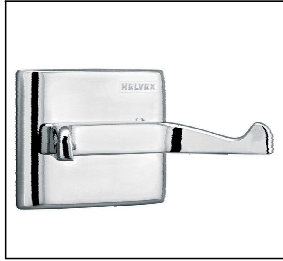
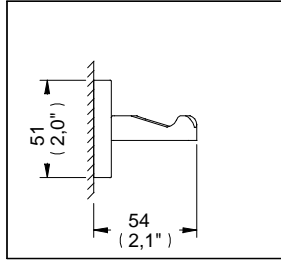

Acot.mm.(pulg)

Despiece

NA

Mod.	Descripción
1 Sa-223	Jgo. de Taq. c/Pijas 10-16 X 1 1/2"
2 Ra-437	Ancla para Atornillar
3 Ra-1063	Tornillo Autorroscante 8-32
4 Ra-220	Porta Ancla p/Base Toallero - T
5 Ra-021	Opresor No 8 X 27/64
6 Ra-024	Base Accesorios p/106-107-108-C

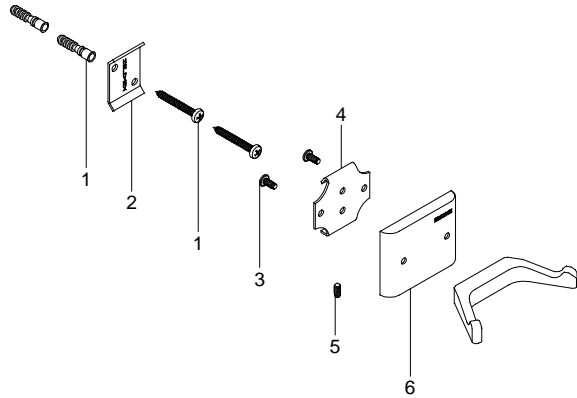

Características y Datos Técnicos

Accesorio de Semiempotrar
Paquete de Sujeción Incluido

Material:
Latón

Portavasos Cepillero Clásica

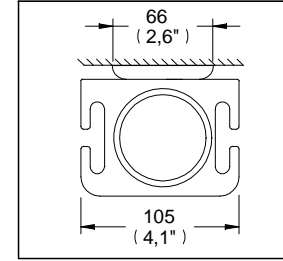
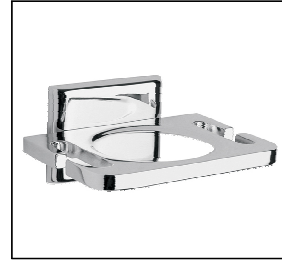

Medidas Referenciales

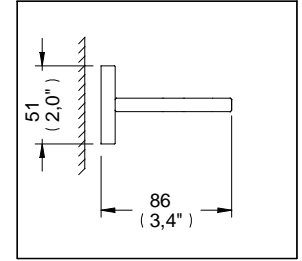

Acot.mm.(pulg)

Despiece

NA

Mod.	Descripción
1 Sa-223	Jgo. de Taq. c/Pijas 10-16 X 1 1/2"
2 Ra-437	Ancla para Atornillar
3 Ra-1063	Tornillo Autorroscante 8-32
4 Ra-220	Porta Ancla p/Base Toallero - T
5 Ra-021	Opresor No 8 X 27/64
6 Ra-024	Base Accesorios p/106-107-108-C

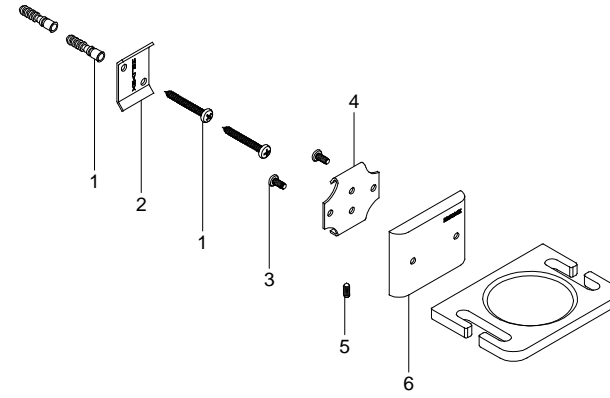

Características y Datos Técnicos

Accesorio de Semiempotrar
Paquete de Sujeción Incluido

Material:
Latón

